

BS213T EXPLODED VIEW

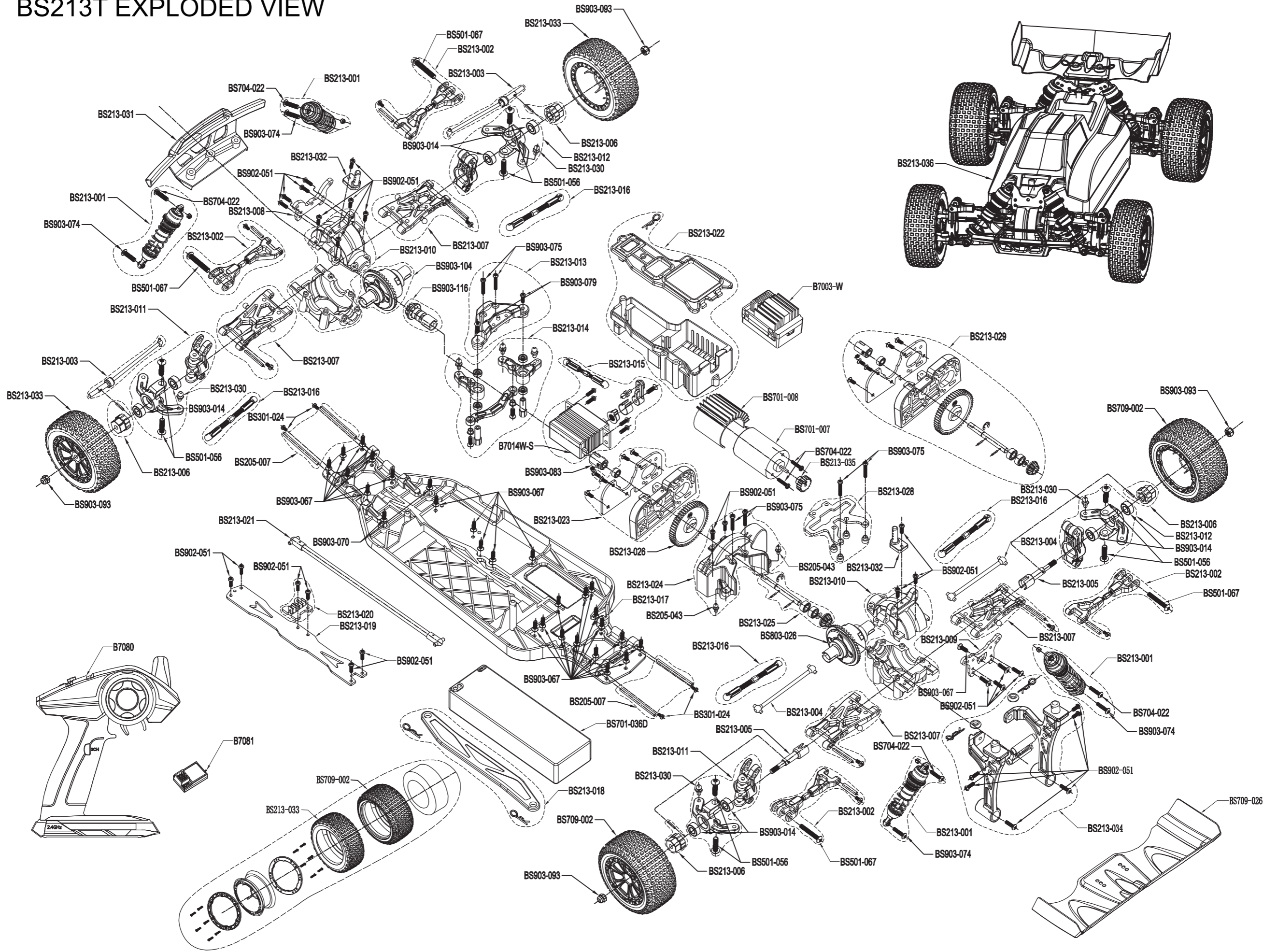

BS213R EXPLODED VIEW

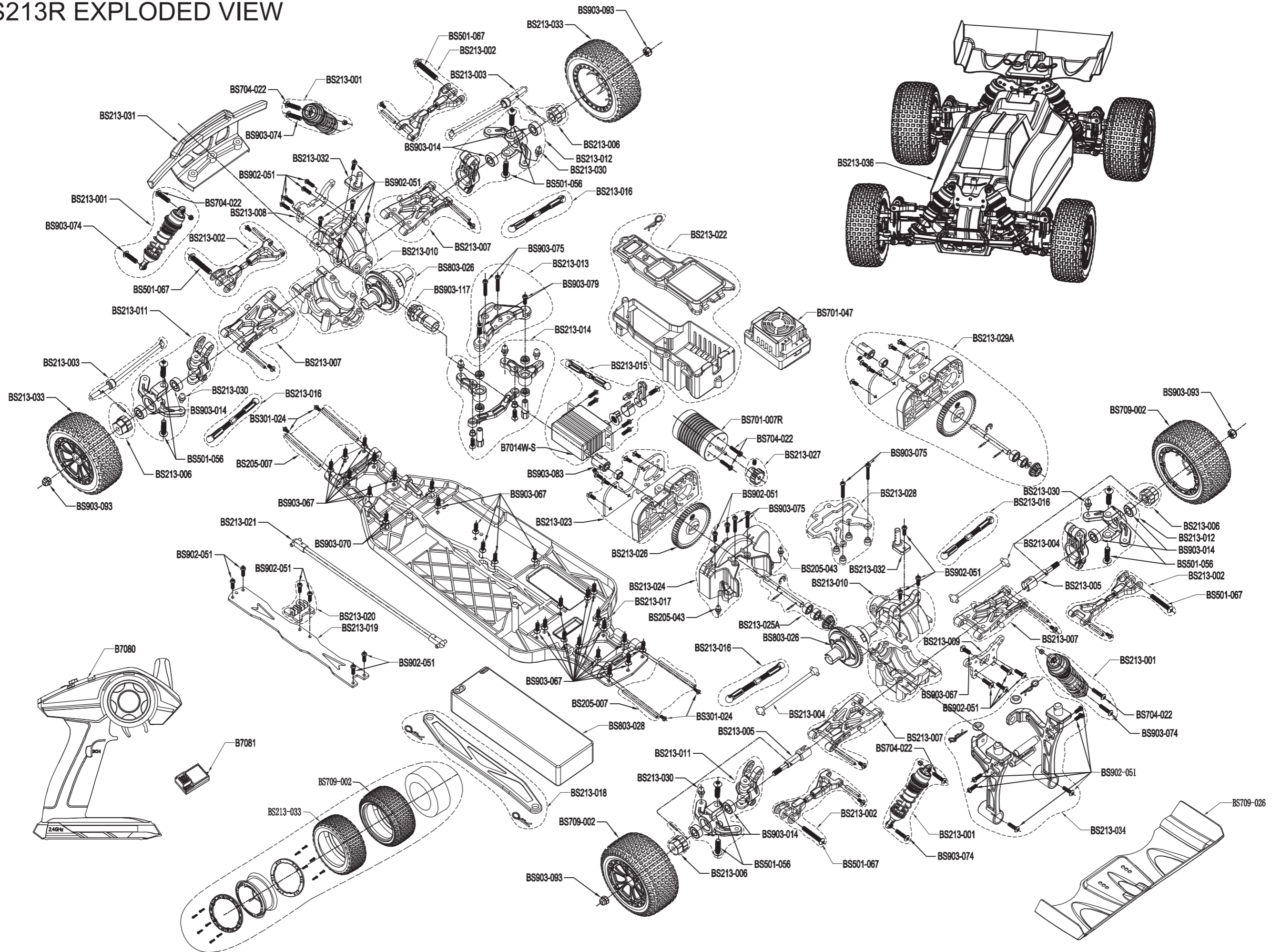

BS213T & BS213R COMMON PARTS

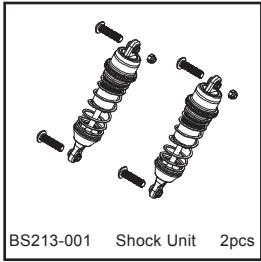

BS213-001 Shock Unit 2pcs

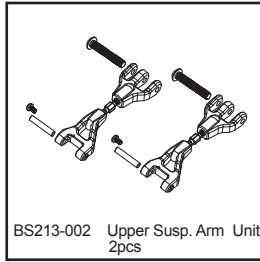

BS213-002 Upper Susp. Arm Unit 2pcs

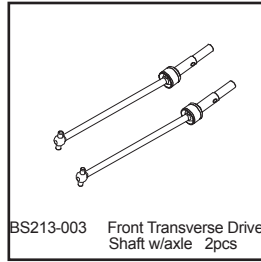

BS213-003 Front Transverse Drive Shaft w/axle 2pcs

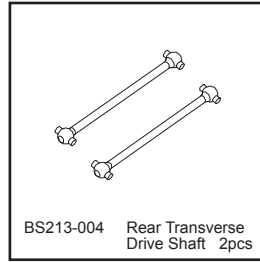

BS213-004 Rear Transverse Drive Shaft 2pcs

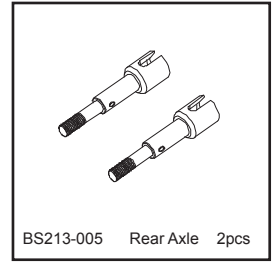

BS213-005 Rear Axle 2pcs

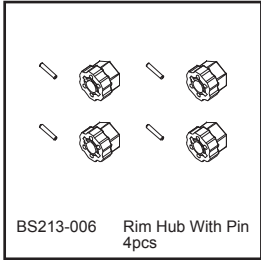

BS213-006 Rim Hub With Pin 4pcs

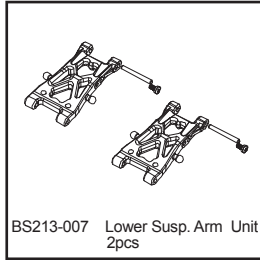

BS213-007 Lower Susp. Arm Unit 2pcs

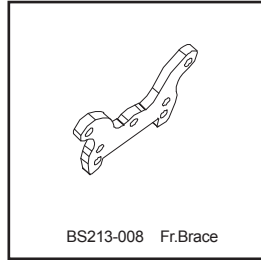

BS213-008 Fr.Brace

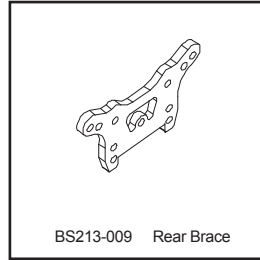

BS213-009 Rear Brace

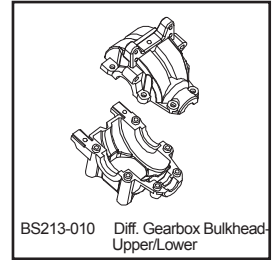

BS213-010 Diff. Gearbox Bulkhead-Upper/Lower

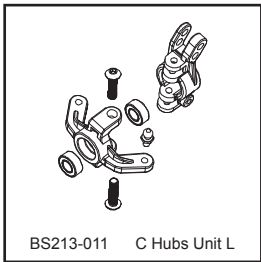

BS213-011 C Hubs Unit L

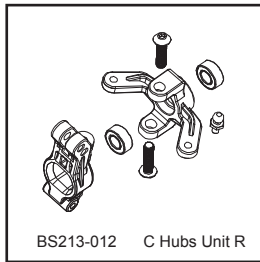

BS213-012 C Hubs Unit R

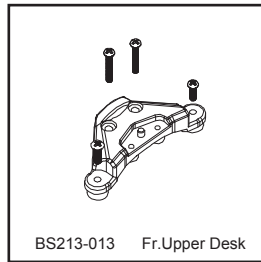

BS213-013 Fr.Upper Desk

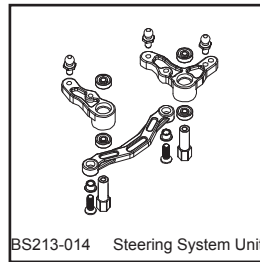

BS213-014 Steering System Unit

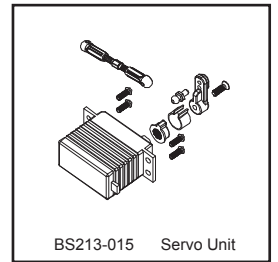

BS213-015 Servo Unit

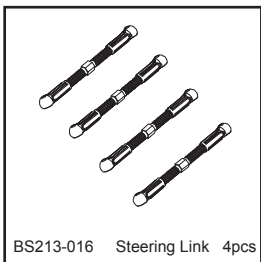

BS213-016 Steering Link 4pcs

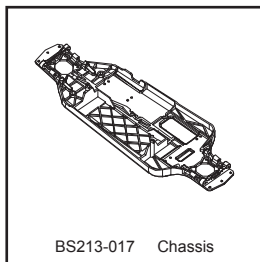

BS213-017 Chassis

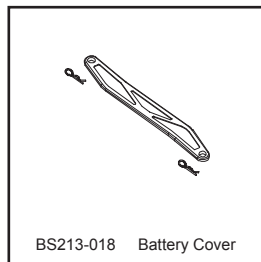

BS213-018 Battery Cover

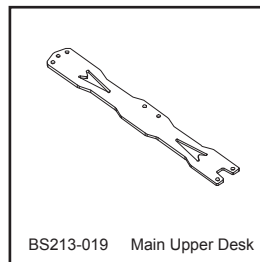

BS213-019 Main Upper Desk

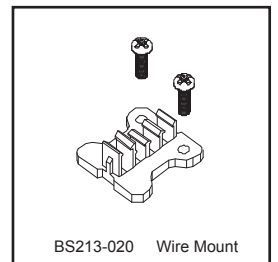

BS213-020 Wire Mount

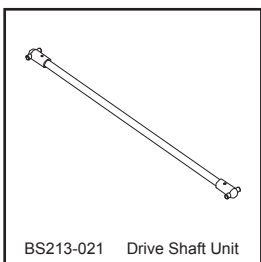

BS213-021 Drive Shaft Unit

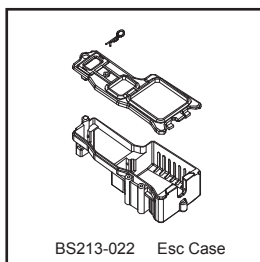

BS213-022 Esc Case

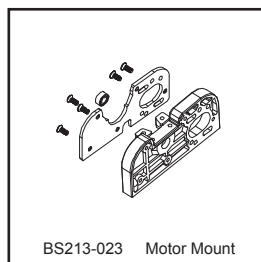

BS213-023 Motor Mount

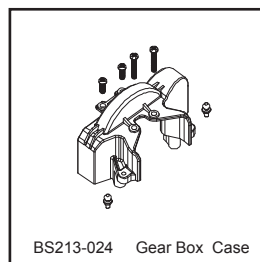

BS213-024 Gear Box Case



BS213-026 Spur Gear 55T

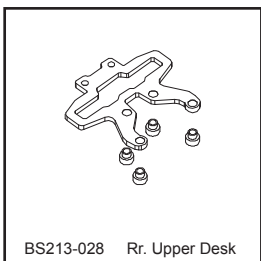

BS213-028 Rr. Upper Desk

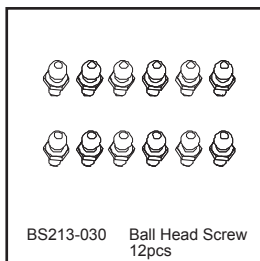

BS213-030 Ball Head Screw 12pcs

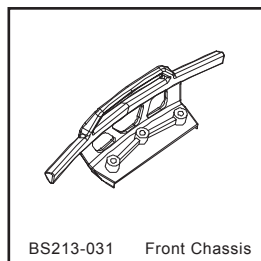

BS213-031 Front Chassis

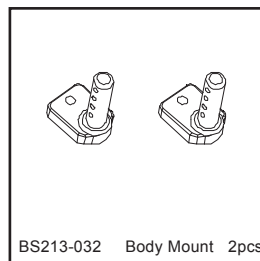

BS213-032 Body Mount 2pcs

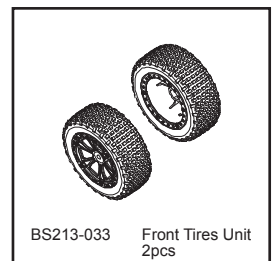

BS213-033 Front Tires Unit 2pcs

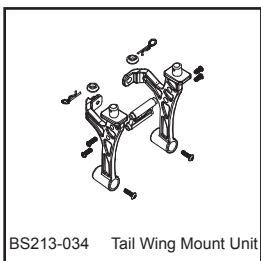

BS213-034 Tail Wing Mount Unit

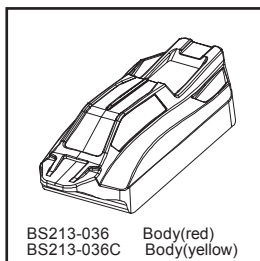

BS213-036 Body(red)
BS213-036C Body(yellow)

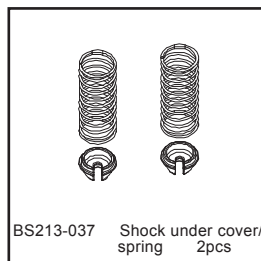

BS213-037 Shock under cover/spring 2pcs

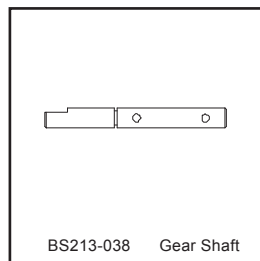

BS213-038 Gear Shaft

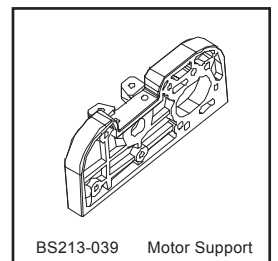

BS213-039 Motor Support

BS213T & BS213R COMMON PARTS

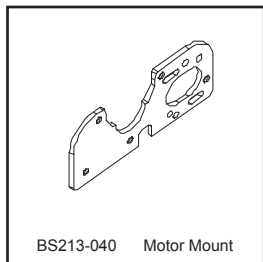

BS213-040 Motor Mount

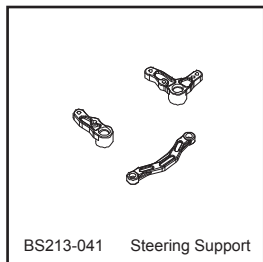

BS213-041 Steering Support

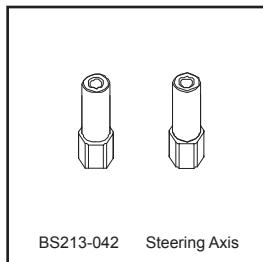

BS213-042 Steering Axis

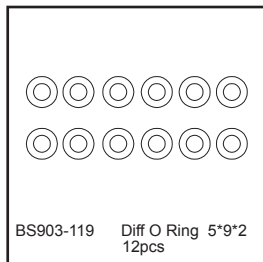

BS903-119 Diff O Ring 5*9*2
12pcs

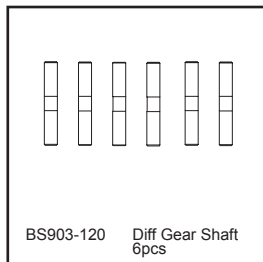

BS903-120 Diff Gear Shaft
6pcs

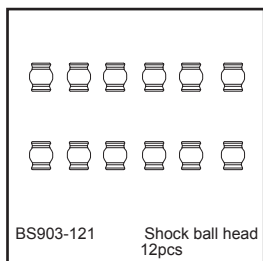

BS903-121 Shock ball head
12pcs

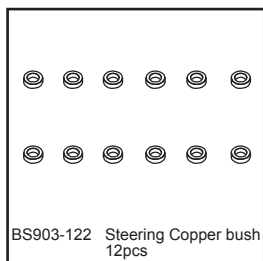

BS903-122 Steering Copper bush
12pcs

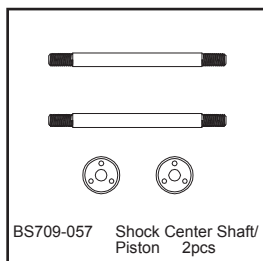

BS709-057 Shock Center Shaft/
Piston 2pcs

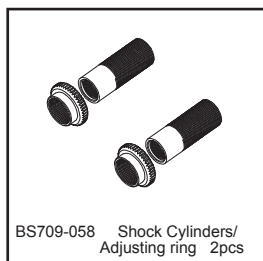

BS709-058 Shock Cylinders/
Adjusting ring 2pcs

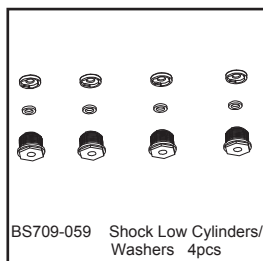

BS709-059 Shock Low Cylinders/
Washers 4pcs

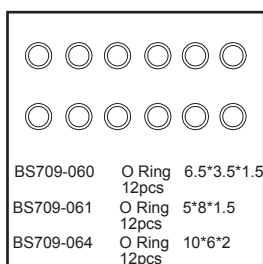

BS709-060 O Ring 6.5*3.5*1.5
12pcs
BS709-061 O Ring 5*8*1.5
12pcs
BS709-064 O Ring 10*6*2
12pcs

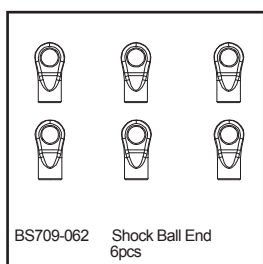

BS709-062 Shock Ball End
6pcs

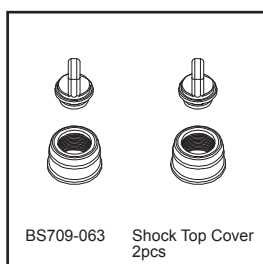

BS709-063 Shock Top Cover
2pcs

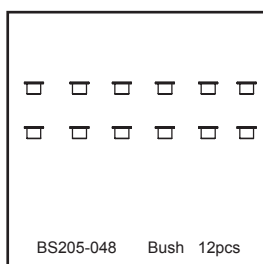

BS205-048 Bush 12pcs

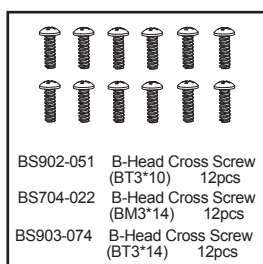

BS902-051 B-Head Cross Screw
(BT3*10) 12pcs
BS704-022 B-Head Cross Screw
(BM3*14) 12pcs
BS903-074 B-Head Cross Screw
(BT3*14) 12pcs

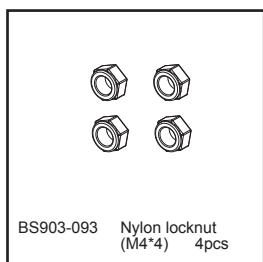

BS903-093 Nylon locknut
(M4*4) 4pcs

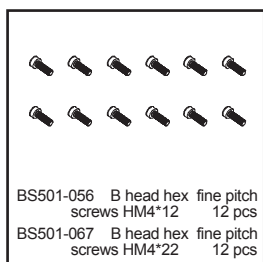

BS501-056 B head hex fine pitch
screws HM4*12 12 pcs
BS501-067 B head hex fine pitch
screws HM4*22 12 pcs

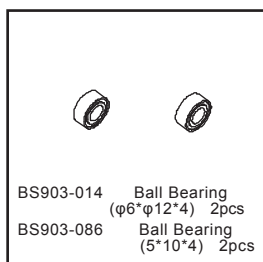

BS903-014 Ball Bearing
(φ6*φ12*4) 2pcs
BS903-086 Ball Bearing
(5*10*4) 2pcs

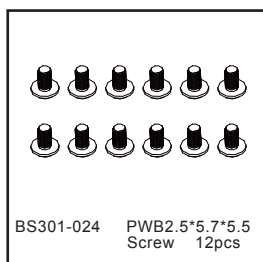

BS301-024 PWB2.5*5.7*5.5
Screw 12pcs

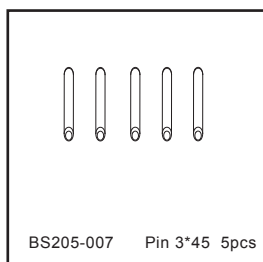

BS205-007 Pin 3*45 5pcs

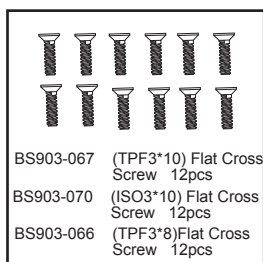

BS903-067 (TPF3*10) Flat Cross
Screw 12pcs
BS903-070 (ISO3*10) Flat Cross
Screw 12pcs
BS903-066 (TPF3*8) Flat Cross
Screw 12pcs

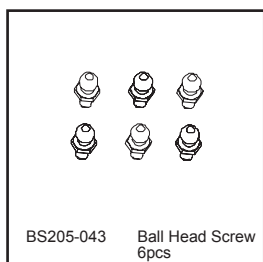

BS205-043 Ball Head Screw
6pcs

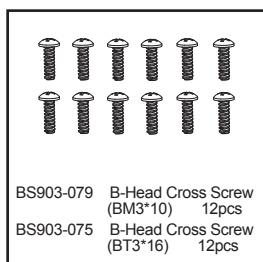

BS903-079 B-Head Cross Screw
(BM3*10) 12pcs
BS903-075 B-Head Cross Screw
(BT3*16) 12pcs

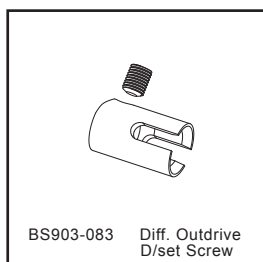

BS903-083 Diff. Outdrive
D/set Screw

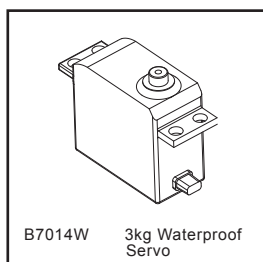

B7014W 3kg Waterproof
Servo

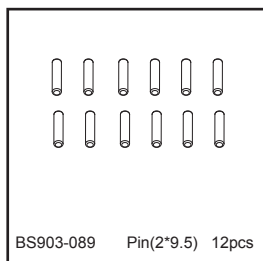

BS903-089 Pin(2*9.5) 12pcs

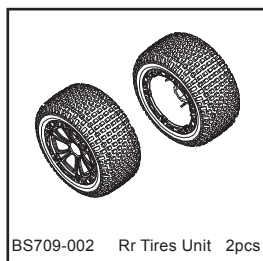

BS709-002 Rr Tires Unit 2pcs

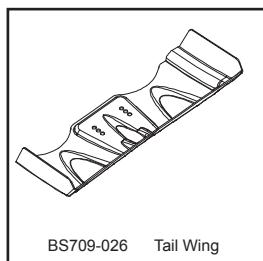

BS709-026 Tail Wing

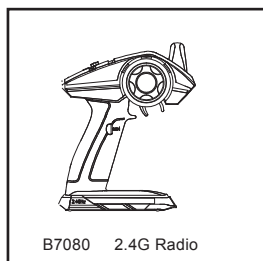

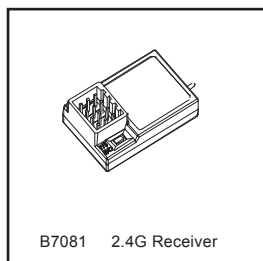

B7080 2.4G Radio





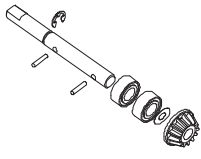
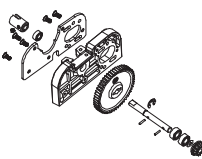

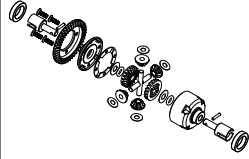
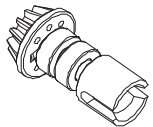
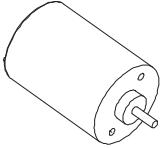
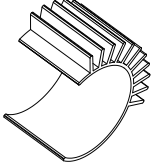
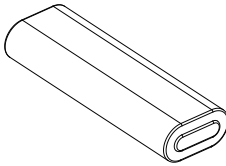
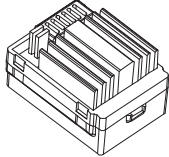
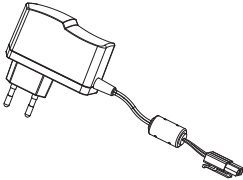
B7081 2.4G Receiver

BS213T PARTS

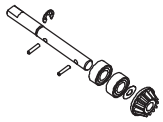
 <p>BS213-025 Gear Shaft Unit (zinc alloy)</p>	 <p>BS213-029 Spur Gear Unit (zinc alloy)</p>	 <p>BS213-035 Motor Gear 20T (plastic)</p>	 <p>BS903-104 Diff. Gear Box Unit (zinc alloy)</p>	 <p>BS903-116 Master Gear Unit (Zinc Alloy)</p>
 <p>BS701-007 550 Motor</p>	 <p>BS701-008 Motor Heat Sink</p>	 <p>BS701-036D 7.2V 1800MAH Battery</p>	 <p>B7003W 1/10 Brushed Waterproof Esc (Tamiya head)</p>	 <p>BS701-035 Charger for 7.2V Ni-MH Battery</p>

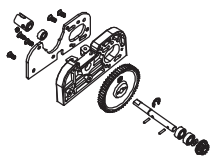
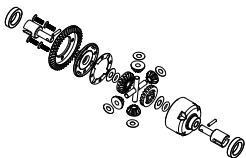
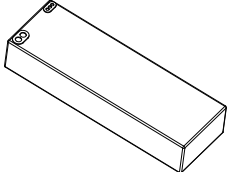
BS213R PARTS

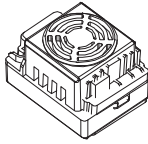
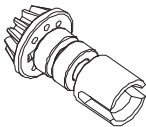
 <p>BS213-025A Gear Shaft unit (steel)</p>	 <p>BS213-027 Motor Gear 20T (metal)</p>	 <p>BS213-029A Spur Gear Unit (steel)</p>	 <p>BS803-026 Diff. Gear Box Unit (steel)</p>	 <p>BS803-028 7.4V 3200 mAh Battery (T head)</p>
 <p>BS701-007R 540 Brushless Motor KV3421</p>	 <p>BS701-047 45A Brushless Waterproof Esc</p>	 <p>BS903-117 Master Gear Unit (steel)</p>		